

BC2.5 Series Battery Connector:



SPECIFICATIONS

Pitch:	2.5 mm
Number of contacts:	3 to 12 pins
Current Rating:	5A, AC, DC
Voltage Rating:	250V, AC, DC
Operating Temperature:	-40 °C ~+85 °C
Relative Humidity:	93%, +40 °C
Dielectric Withstanding:	1000V AC/minute
Contact Resistance:	≤ 20 mΩ/Contact
Insulator Resistance:	≥ 500 MΩ at 100V
Material:	
Base:	PBT/Nylon6T, UL94V-0
Contact Pin:	Phosphor Bronze
ROHS Compliance	

BC2.5-XA

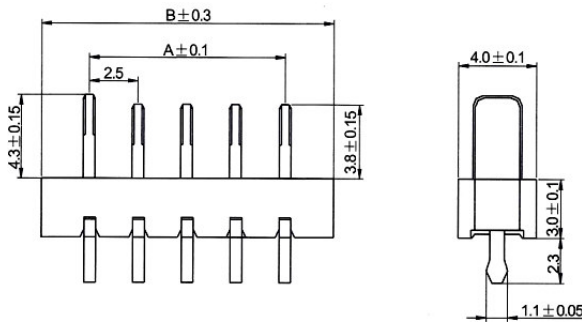

BC2.5-XAW

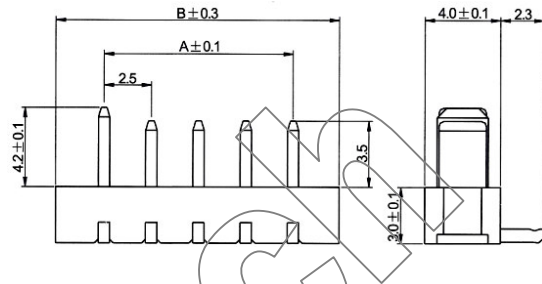

BC2.5-XAWD

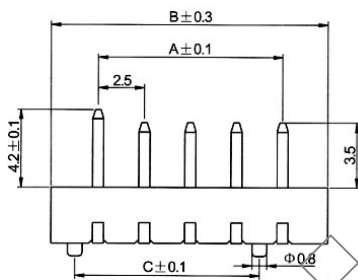

BC2.5-XP

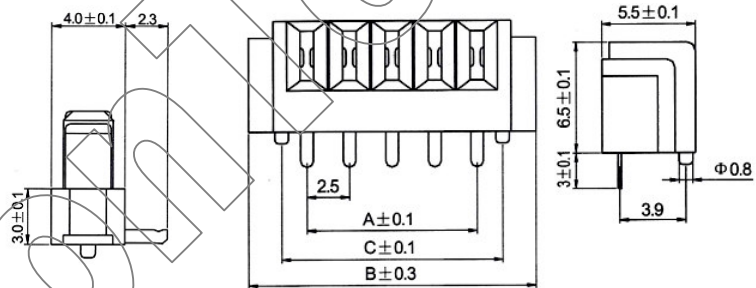

BC2.5-XPW

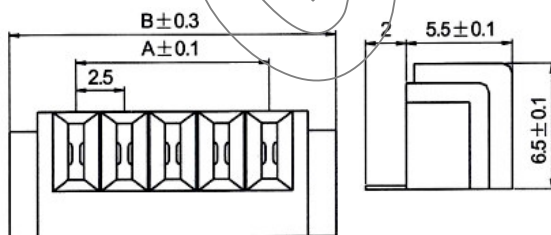

BC2.5-1-XA

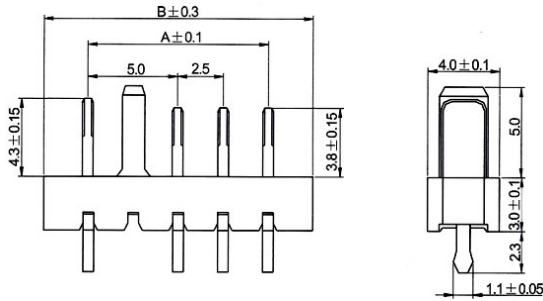

BC2.5-1-XAWD

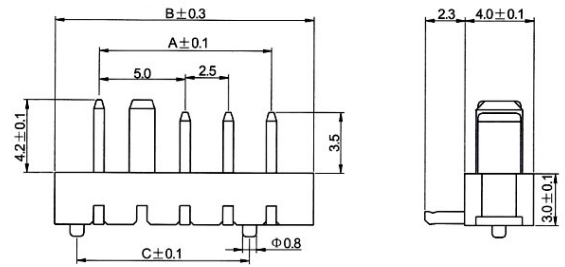

BC2.5-1-XAWS

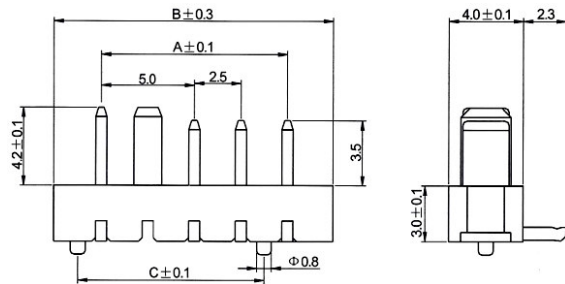

BC2.5-1-XAWG

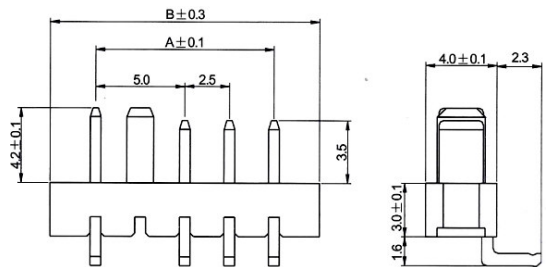

BC2.5-1-XP

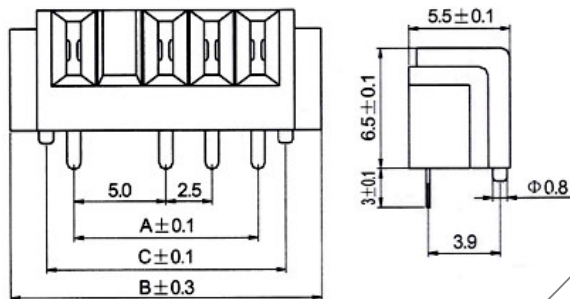

BC2.5-1-XPS

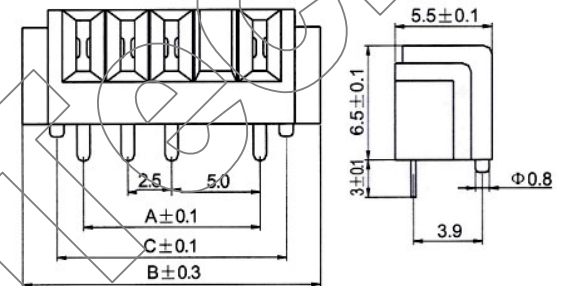

BC2.5-1-XPW

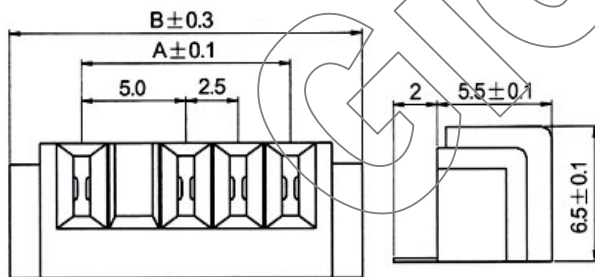

BC2.5-2-XA

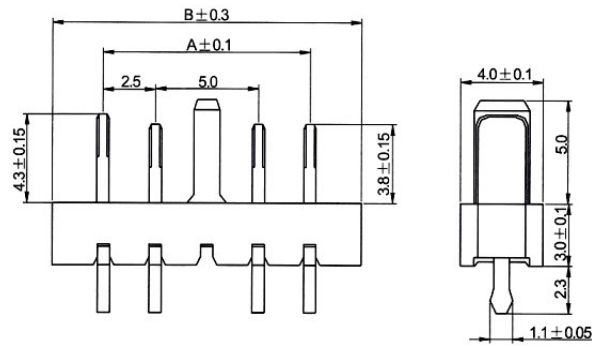

BC2.5-2-XAWD

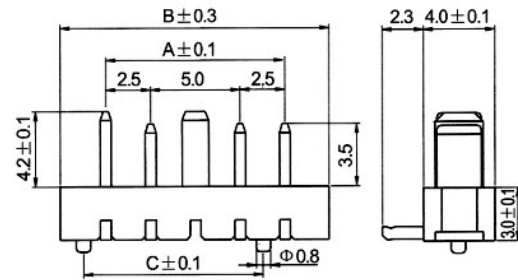

BC2.5-2-XAWSD

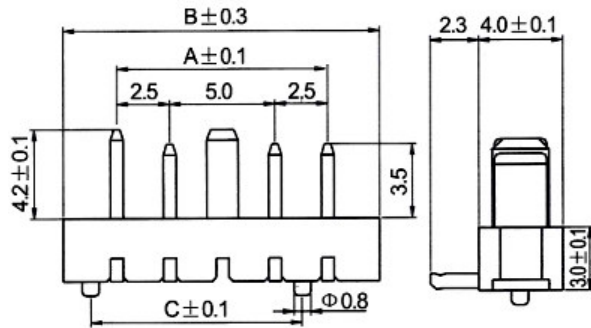

BC2.5-2-XP

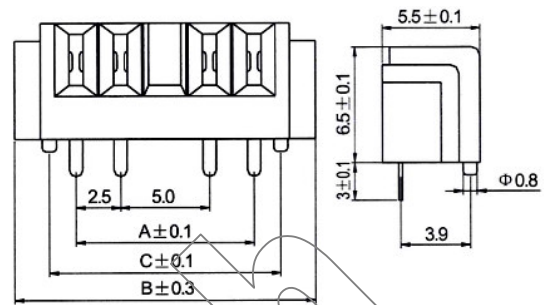

Note:

A=Nx2.5-2.5

B=A+2.5

C=A+5.0

